



# PBSS4160DPN

60 V, 1 A NPN/PNP low  $V_{CEsat}$  (BISS) transistor

Rev. 02 — 14 July 2005

Product data sheet

## 1. Product profile

### 1.1 General description

NPN/PNP low  $V_{CEsat}$  Breakthrough in Small Signal (BISS) transistor pair in a SOT457 (SC-74) Surface Mounted Device (SMD) plastic package.

### 1.2 Features

- Low collector-emitter saturation voltage  $V_{CEsat}$
- High collector current capability:  $I_C$  and  $I_{CM}$
- High collector current gain ( $h_{FE}$ ) at high  $I_C$
- High efficiency due to less heat generation
- Smaller required Printed-Circuit Board (PCB) area than for conventional transistors

### 1.3 Applications

- Complementary MOSFET driver
- Half and full bridge motor drivers
- Dual low power switches (e.g. motors, fans)
- Automotive applications

### 1.4 Quick reference data

Table 1: Quick reference data

Symbol	Parameter	Conditions	Min	Typ	Max	Unit	
<b>TR1 (NPN)</b>							
$V_{CEO}$	collector-emitter voltage	open base	-	-	60	V	
$I_C$	collector current (DC)		[1]	-	1	A	
$I_{CM}$	peak collector current	single pulse; $t_p \leq 1$ ms	-	-	2	A	
$R_{CEsat}$	collector-emitter saturation resistance	$I_C = 1$ A; $I_B = 100$ mA	[2]	-	200	250	m $\Omega$
<b>TR2 (PNP)</b>							
$V_{CEO}$	collector-emitter voltage	open base	-	-	-60	V	
$I_C$	collector current (DC)		[1]	-	-900	mA	
$I_{CM}$	peak collector current	single pulse; $t_p \leq 1$ ms	-	-	-2	A	
$R_{CEsat}$	collector-emitter saturation resistance	$I_C = -1$ A; $I_B = -100$ mA	[2]	-	250	330	m $\Omega$

[1] Device mounted on an FR4 PCB, single-sided copper, tin-plated, mounting pad for collector 1 cm<sup>2</sup>.

[2] Pulse test:  $t_p \leq 300$   $\mu$ s;  $\delta \leq 0.02$ .

## 2. Pinning information

**Table 2: Pinning**

Pin	Description	Simplified outline	Symbol
1	emitter TR1		
2	base TR1		
3	collector TR2		
4	emitter TR2		
5	base TR2		
6	collector TR1		

*sym019*

## 3. Ordering information

**Table 3: Ordering information**

Type number	Package		
	Name	Description	Version
PBSS4160DPN	SC-74	plastic surface mounted package; 6 leads	SOT457

## 4. Marking

**Table 4: Marking codes**

Type number	Marking code
PBSS4160DPN	B4

## 5. Limiting values

**Table 5: Limiting values**

*In accordance with the Absolute Maximum Rating System (IEC 60134).*

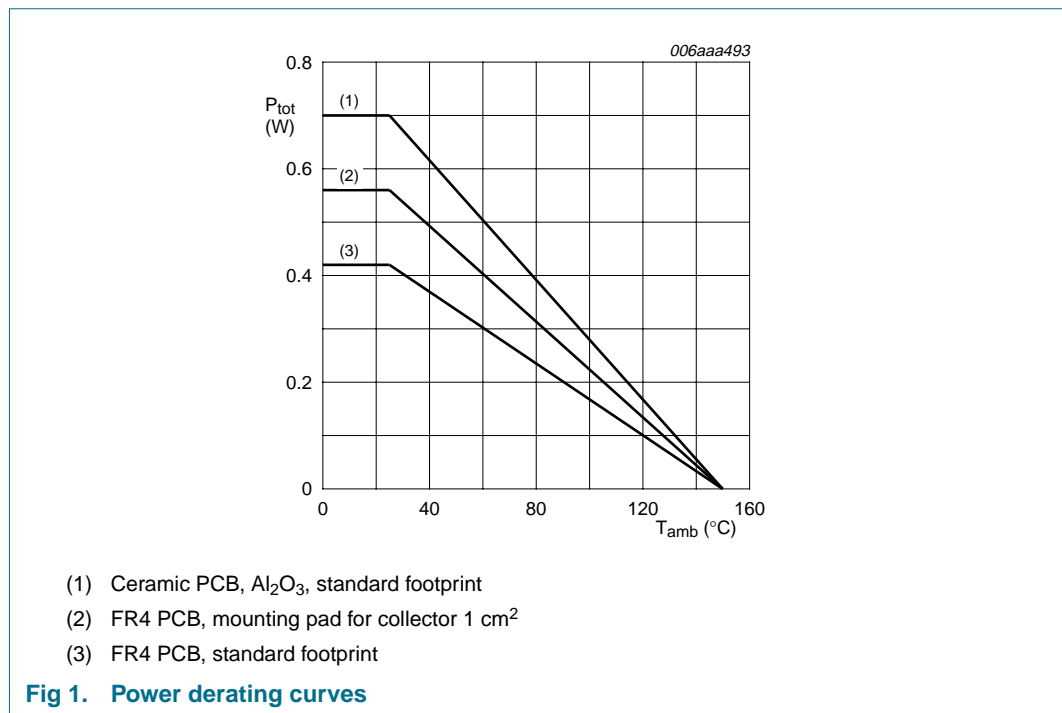
Symbol	Parameter	Conditions	Min	Max	Unit		
<b>Per transistor unless otherwise specified; for the PNP transistor with negative polarity</b>							
$V_{CBO}$	collector-base voltage	open emitter	-	80	V		
$V_{CEO}$	collector-emitter voltage	open base	-	60	V		
$V_{EBO}$	emitter-base voltage	open collector	-	5	V		
$I_C$	collector current (DC)	NPN	[1]	-	870	mA	
			[2]	-	1	A	
		PNP	[1]	-	770	mA	
			[2]	-	900	mA	
		both		[3]	-	1	A
		$I_{CM}$	peak collector current	single pulse; $t_p \leq 1$ ms	-	2	A
$I_B$	base current (DC)		-	300	mA		
$I_{BM}$	peak base current	single pulse; $t_p \leq 1$ ms	-	1	A		

**Table 5: Limiting values ...continued**

In accordance with the Absolute Maximum Rating System (IEC 60134).

Symbol	Parameter	Conditions	Min	Max	Unit	
$P_{tot}$	total power dissipation	$T_{amb} \leq 25\text{ °C}$	[1]	-	290	mW
			[2]	-	370	mW
			[3]	-	450	mW
<b>Per device</b>						
$P_{tot}$	total power dissipation	$T_{amb} \leq 25\text{ °C}$	[1]	-	420	mW
			[2]	-	560	mW
			[3]	-	700	mW
$T_j$	junction temperature		-	150	°C	
$T_{amb}$	ambient temperature		-65	+150	°C	
$T_{stg}$	storage temperature		-65	+150	°C	

- [1] Device mounted on an FR4 PCB, single-sided copper, tin-plated and standard footprint.
- [2] Device mounted on an FR4 PCB, single-sided copper, tin-plated, mounting pad for collector 1 cm<sup>2</sup>.
- [3] Device mounted on a ceramic PCB, Al<sub>2</sub>O<sub>3</sub>, standard footprint.

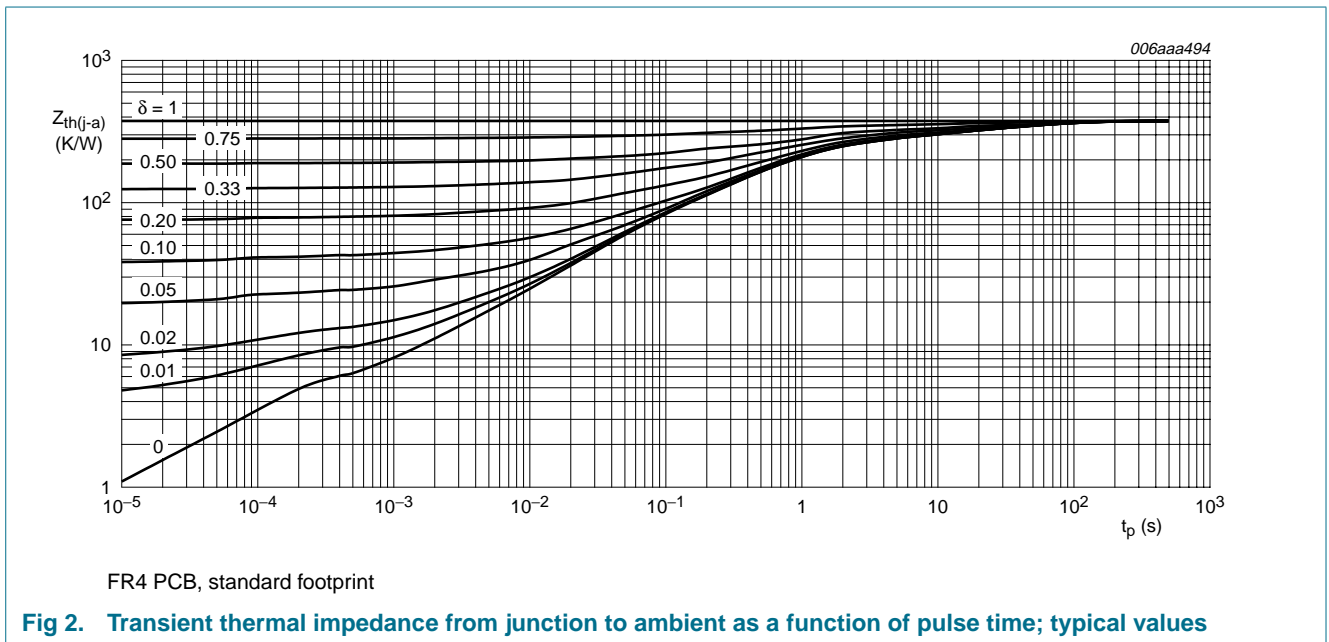


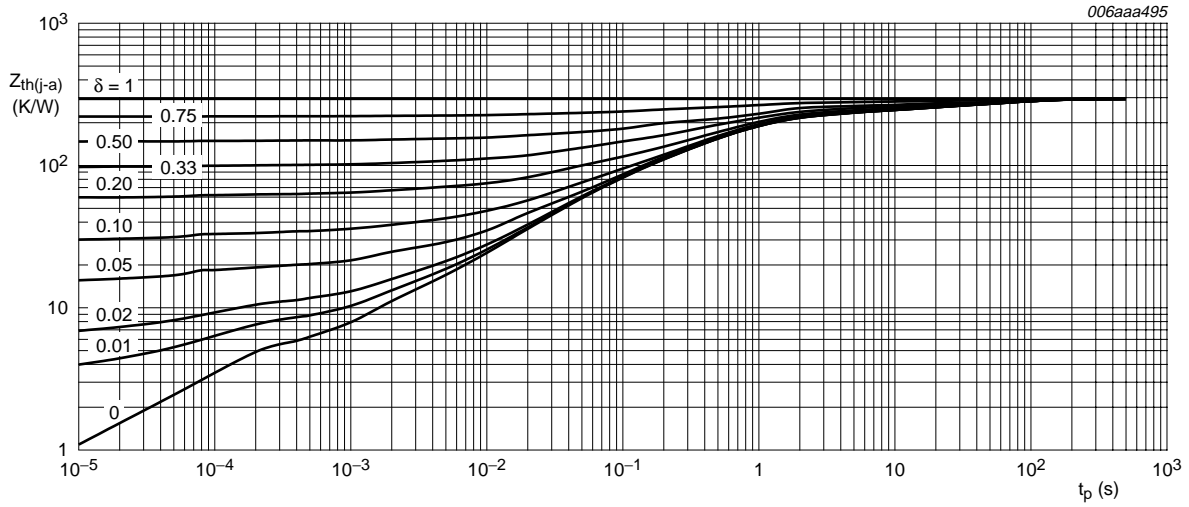
## 6. Thermal characteristics

**Table 6: Thermal characteristics**

Symbol	Parameter	Conditions	Min	Typ	Max	Unit	
$R_{th(j-a)}$	thermal resistance from junction to ambient	in free air	[1]	-	-	431	K/W
			[2]	-	-	338	K/W
			[3]	-	-	278	K/W
$R_{th(j-sp)}$	thermal resistance from junction to solder point		-	-	105	K/W	

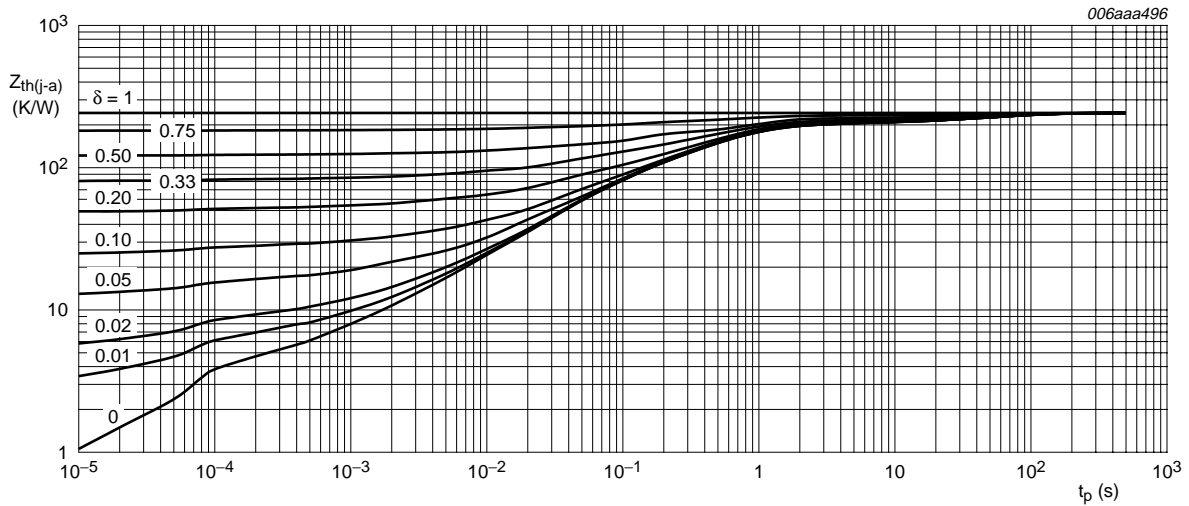
- [1] Device mounted on an FR4 PCB, single-sided copper, tin-plated and standard footprint.
- [2] Device mounted on an FR4 PCB, single-sided copper, tin-plated, mounting pad for collector 1 cm<sup>2</sup>.
- [3] Device mounted on a ceramic PCB, Al<sub>2</sub>O<sub>3</sub>, standard footprint.





FR4 PCB, mounting pad for collector 1 cm<sup>2</sup>

**Fig 3. Transient thermal impedance from junction to ambient as a function of pulse time; typical values**



Ceramic PCB, Al<sub>2</sub>O<sub>3</sub>, standard footprint

**Fig 4. Transient thermal impedance from junction to ambient as a function of pulse time; typical values**

## 7. Characteristics

**Table 7: Characteristics**

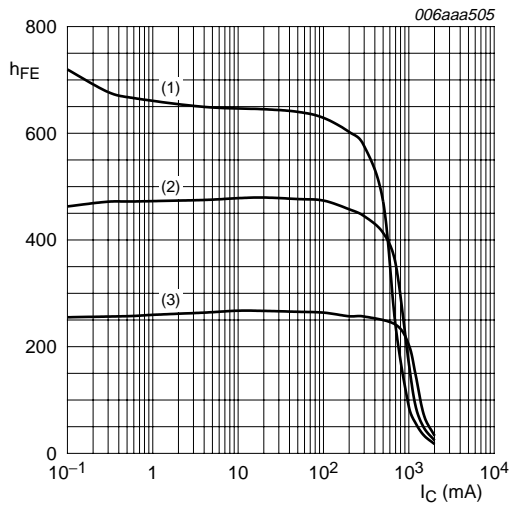
$T_{amb} = 25^\circ\text{C}$  unless otherwise specified.

Symbol	Parameter	Conditions	Min	Typ	Max	Unit	
<b>Per transistor unless otherwise specified; for the PNP transistor with negative polarity</b>							
$I_{CBO}$	collector-base cut-off current	$V_{CB} = 60\text{ V}; I_E = 0\text{ A}$	-	-	100	nA	
		$V_{CB} = 60\text{ V}; I_E = 0\text{ A}; T_j = 150^\circ\text{C}$	-	-	50	$\mu\text{A}$	
$I_{CES}$	collector-emitter cut-off current	$V_{CE} = 60\text{ V}; V_{BE} = 0\text{ V}$	-	-	100	nA	
$I_{EBO}$	emitter-base cut-off current	$V_{EB} = 5\text{ V}; I_C = 0\text{ A}$	-	-	100	nA	
$V_{BEsat}$	base-emitter saturation voltage	$I_C = 1\text{ A}; I_B = 50\text{ mA}$	[1]	0.95	1.1	V	
$V_{BEon}$	base-emitter turn-on voltage	$V_{CE} = 5\text{ V}; I_C = 1\text{ A}$	[1]	0.82	0.9	V	
<b>TR1 (NPN)</b>							
$h_{FE}$	DC current gain	$V_{CE} = 5\text{ V}; I_C = 1\text{ mA}$	250	500	-		
		$V_{CE} = 5\text{ V}; I_C = 500\text{ mA}$	[1] 200	420	-		
		$V_{CE} = 5\text{ V}; I_C = 1\text{ A}$	[1] 100	180	-		
$V_{CEsat}$	collector-emitter saturation voltage	$I_C = 100\text{ mA}; I_B = 1\text{ mA}$	-	90	110	mV	
		$I_C = 500\text{ mA}; I_B = 50\text{ mA}$	-	115	140	mV	
		$I_C = 1\text{ A}; I_B = 100\text{ mA}$	[1]	-	200	250	mV
$R_{CEsat}$	collector-emitter saturation resistance	$I_C = 1\text{ A}; I_B = 100\text{ mA}$	[1]	-	200	250	$\text{m}\Omega$
$t_d$	delay time	$I_C = 0.5\text{ A}; I_{Bon} = 25\text{ mA}; I_{Boff} = -25\text{ mA}$	-	11	-	ns	
$t_r$	rise time		-	78	-	ns	
$t_{on}$	turn-on time		-	90	-	ns	
$t_s$	storage time		-	340	-	ns	
$t_f$	fall time		-	160	-	ns	
$t_{off}$	turn-off time		-	500	-	ns	
$f_T$	transition frequency	$V_{CE} = 10\text{ V}; I_C = 50\text{ mA}; f = 100\text{ MHz}$	150	220	-	MHz	
$C_c$	collector capacitance	$V_{CB} = 10\text{ V}; I_E = I_e = 0\text{ A}; f = 1\text{ MHz}$	-	5.5	10	pF	
<b>TR2 (PNP)</b>							
$h_{FE}$	DC current gain	$V_{CE} = -5\text{ V}; I_C = -1\text{ mA}$	200	350	-		
		$V_{CE} = -5\text{ V}; I_C = -500\text{ mA}$	[1] 150	250	-		
		$V_{CE} = -5\text{ V}; I_C = -1\text{ A}$	[1] 100	160	-		

**Table 7: Characteristics ...continued**  
 $T_{amb} = 25^\circ\text{C}$  unless otherwise specified.

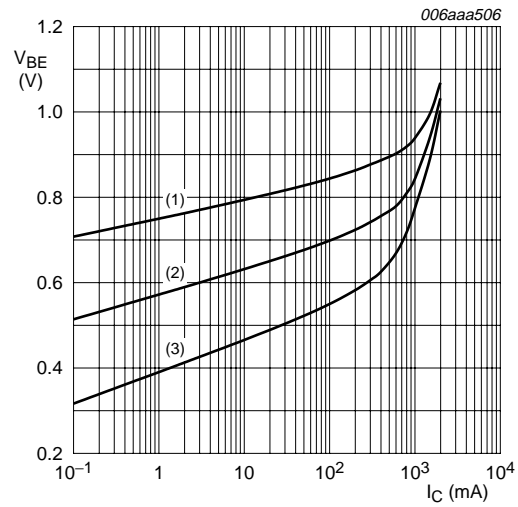
Symbol	Parameter	Conditions	Min	Typ	Max	Unit	
$V_{CEsat}$	collector-emitter saturation voltage	$I_C = -100\text{ mA};$ $I_B = -1\text{ mA}$	-	-110	-165	mV	
		$I_C = -500\text{ mA};$ $I_B = -50\text{ mA}$	-	-120	-175	mV	
		$I_C = -1\text{ A};$ $I_B = -100\text{ mA}$	[1]	-	-250	-330	mV
$R_{CEsat}$	collector-emitter saturation resistance	$I_C = -1\text{ A};$ $I_B = -100\text{ mA}$	[1]	-	250	330	$\text{m}\Omega$
$t_d$	delay time	$I_C = -0.5\text{ A};$	-	11	-	ns	
$t_r$	rise time	$I_{Bon} = -25\text{ mA};$ $I_{Boff} = 25\text{ mA}$	-	30	-	ns	
$t_{on}$	turn-on time		-	41	-	ns	
$t_s$	storage time		-	205	-	ns	
$t_f$	fall time		-	55	-	ns	
$t_{off}$	turn-off time		-	260	-	ns	
$f_T$	transition frequency	$V_{CE} = -10\text{ V};$ $I_C = -50\text{ mA};$ $f = 100\text{ MHz}$	150	185	-	MHz	
$C_c$	collector capacitance	$V_{CB} = -10\text{ V};$ $I_E = I_e = 0\text{ A}; f = 1\text{ MHz}$	-	9	15	pF	

[1] Pulse test:  $t_p \leq 300\text{ }\mu\text{s}; \delta \leq 0.02$ .



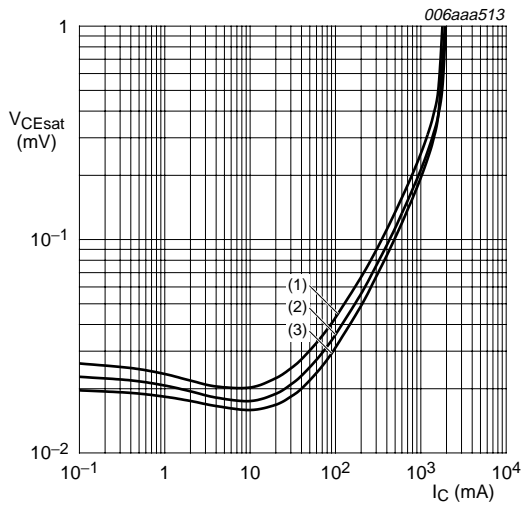
$V_{CE} = 5\text{ V}$   
 (1)  $T_{amb} = 100\text{ °C}$   
 (2)  $T_{amb} = 25\text{ °C}$   
 (3)  $T_{amb} = -55\text{ °C}$

**Fig 5. TR1 (NPN): DC current gain as a function of collector current; typical values**



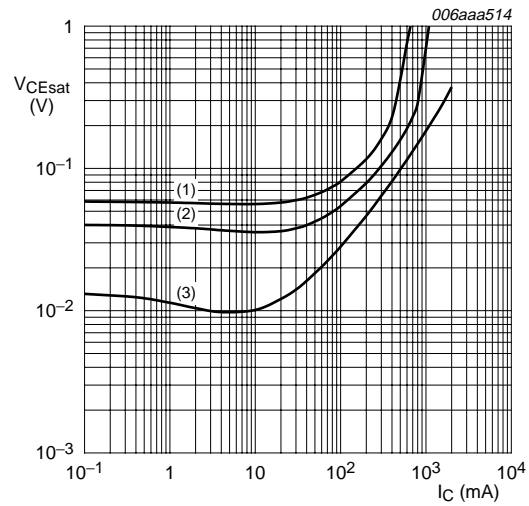
$V_{CE} = 5\text{ V}$   
 (1)  $T_{amb} = -55\text{ °C}$   
 (2)  $T_{amb} = 25\text{ °C}$   
 (3)  $T_{amb} = 100\text{ °C}$

**Fig 6. TR1 (NPN): Base-emitter voltage as a function of collector current; typical values**



$I_C/I_B = 20$   
 (1)  $T_{amb} = 100\text{ °C}$   
 (2)  $T_{amb} = 25\text{ °C}$   
 (3)  $T_{amb} = -55\text{ °C}$

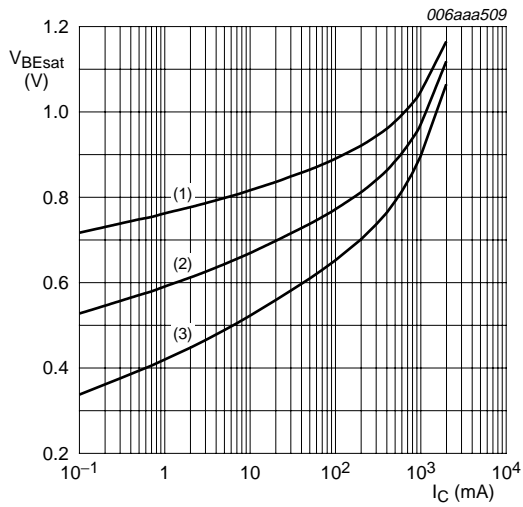
**Fig 7. TR1 (NPN): Collector-emitter saturation voltage as a function of collector current; typical values**



$T_{amb} = 25\text{ °C}$   
 (1)  $I_C/I_B = 100$   
 (2)  $I_C/I_B = 50$   
 (3)  $I_C/I_B = 10$

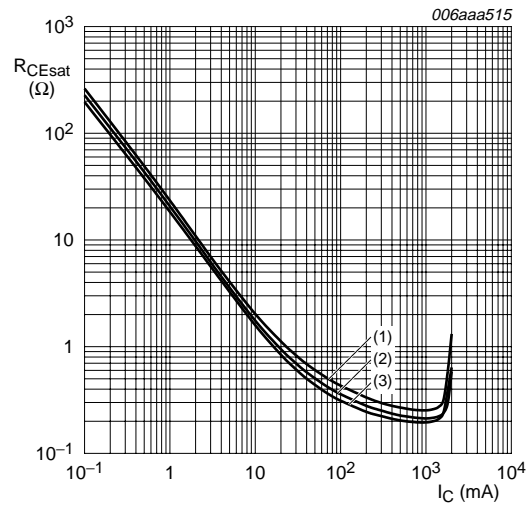
**Fig 8. TR1 (NPN): Collector-emitter saturation voltage as a function of collector current; typical values**





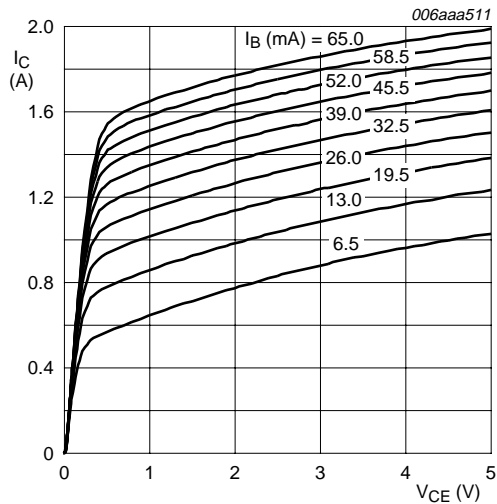
$I_C/I_B = 20$   
 (1)  $T_{amb} = -55\text{ °C}$   
 (2)  $T_{amb} = 25\text{ °C}$   
 (3)  $T_{amb} = 100\text{ °C}$

**Fig 9. TR1 (NPN): Base-emitter saturation voltage as a function of collector current; typical values**



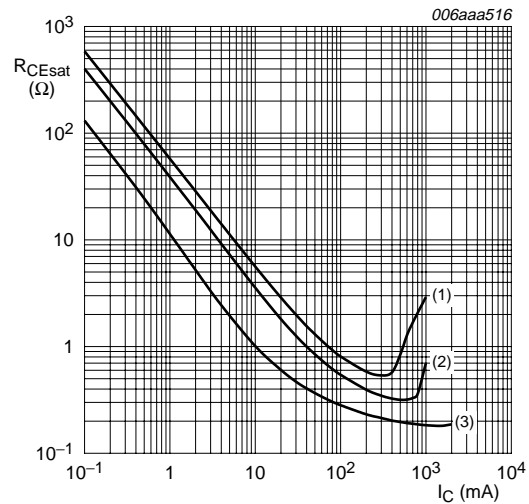
$I_C/I_B = 20$   
 (1)  $T_{amb} = 100\text{ °C}$   
 (2)  $T_{amb} = 25\text{ °C}$   
 (3)  $T_{amb} = -55\text{ °C}$

**Fig 10. TR1 (NPN): Collector-emitter saturation resistance as a function of collector current; typical values**



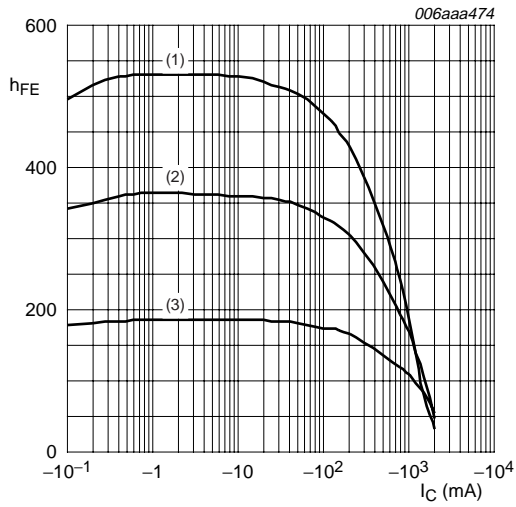
$T_{amb} = 25\text{ °C}$

**Fig 11. TR1 (NPN): Collector current as a function of collector-emitter voltage; typical values**



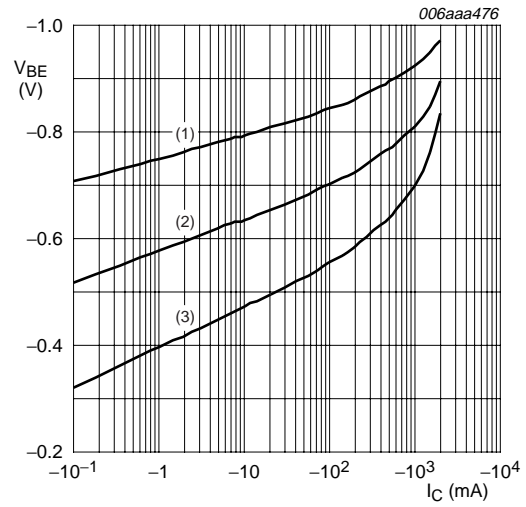
$T_{amb} = 25\text{ °C}$   
 (1)  $I_C/I_B = 100$   
 (2)  $I_C/I_B = 50$   
 (3)  $I_C/I_B = 10$

**Fig 12. TR1 (NPN): Collector-emitter saturation resistance as a function of collector current; typical values**



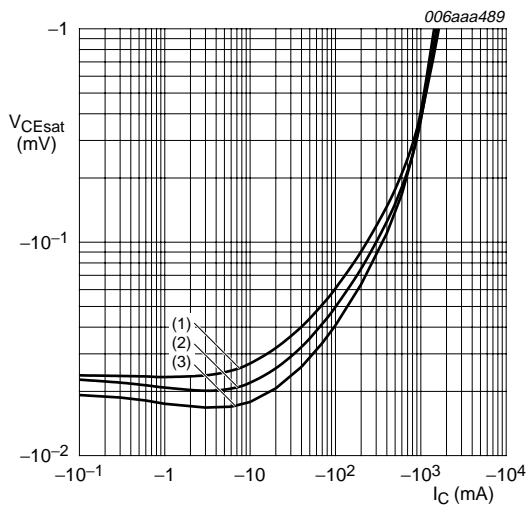
$V_{CE} = -5\text{ V}$   
 (1)  $T_{amb} = 100\text{ °C}$   
 (2)  $T_{amb} = 25\text{ °C}$   
 (3)  $T_{amb} = -55\text{ °C}$

**Fig 13. TR2 (PNP): DC current gain as a function of collector current; typical values**



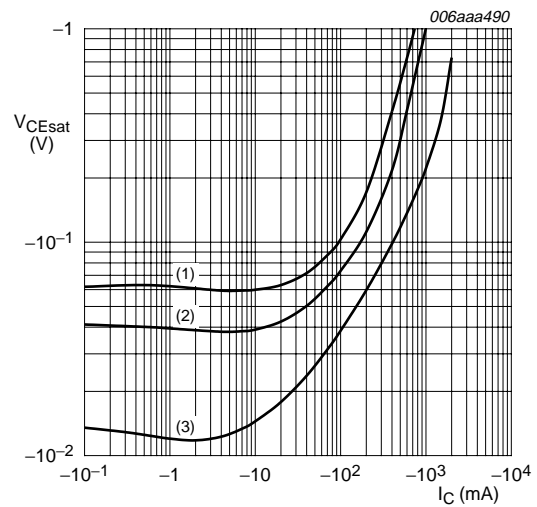
$V_{CE} = -5\text{ V}$   
 (1)  $T_{amb} = -55\text{ °C}$   
 (2)  $T_{amb} = 25\text{ °C}$   
 (3)  $T_{amb} = 100\text{ °C}$

**Fig 14. TR2 (PNP): Base-emitter voltage as a function of collector current; typical values**



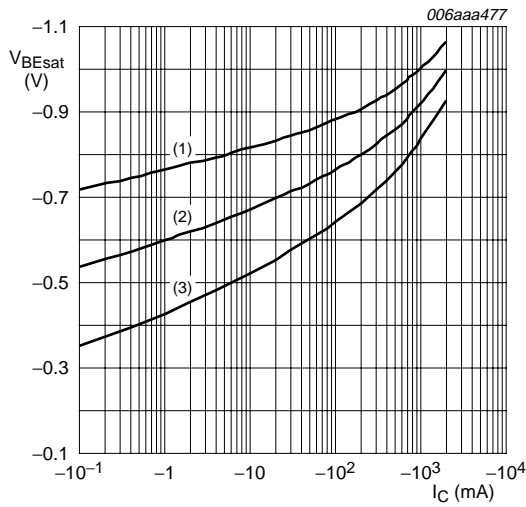
$I_C/I_B = 20$   
 (1)  $T_{amb} = 100\text{ °C}$   
 (2)  $T_{amb} = 25\text{ °C}$   
 (3)  $T_{amb} = -55\text{ °C}$

**Fig 15. TR2 (PNP): Collector-emitter saturation voltage as a function of collector current; typical values**



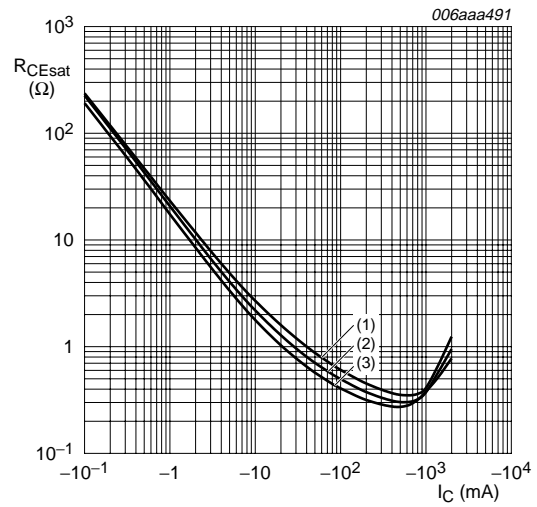
$T_{amb} = 25\text{ °C}$   
 (1)  $I_C/I_B = 100$   
 (2)  $I_C/I_B = 50$   
 (3)  $I_C/I_B = 10$

**Fig 16. TR2 (PNP): Collector-emitter saturation voltage as a function of collector current; typical values**



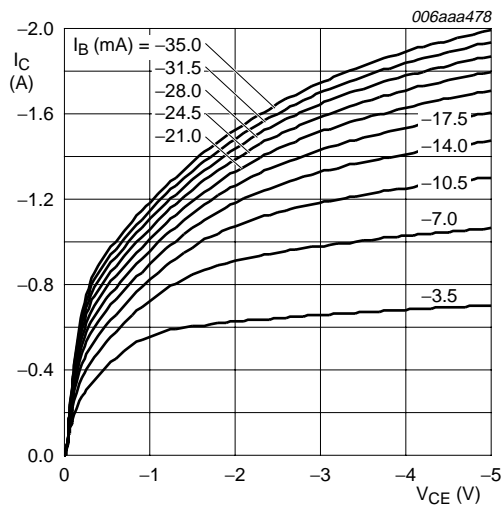
$I_C/I_B = 20$   
 (1)  $T_{amb} = -55\text{ °C}$   
 (2)  $T_{amb} = 25\text{ °C}$   
 (3)  $T_{amb} = 100\text{ °C}$

**Fig 17. TR2 (PNP): Base-emitter saturation voltage as a function of collector current; typical values**



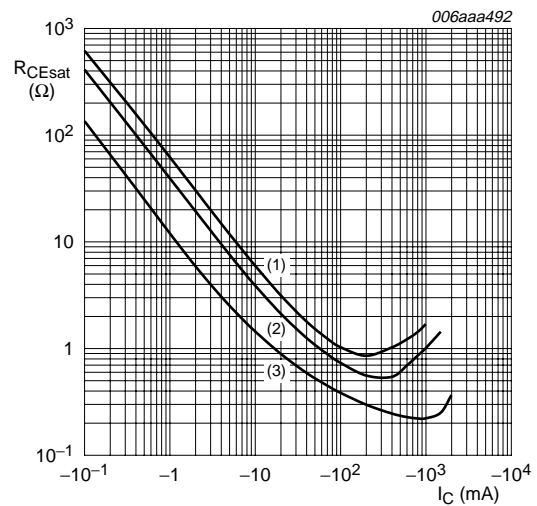
$I_C/I_B = 20$   
 (1)  $T_{amb} = 100\text{ °C}$   
 (2)  $T_{amb} = 25\text{ °C}$   
 (3)  $T_{amb} = -55\text{ °C}$

**Fig 18. TR2 (PNP): Collector-emitter saturation resistance as a function of collector current; typical values**



$T_{amb} = 25\text{ °C}$

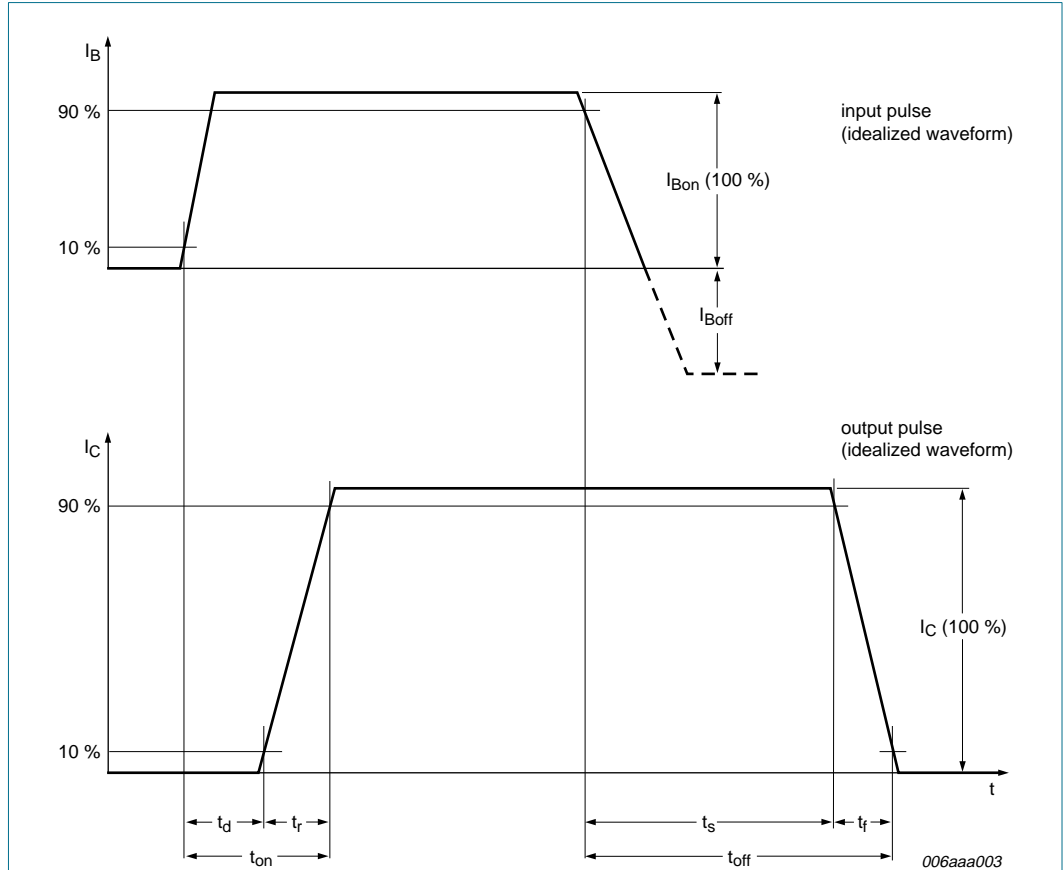
**Fig 19. TR2 (PNP): Collector current as a function of collector-emitter voltage; typical values**



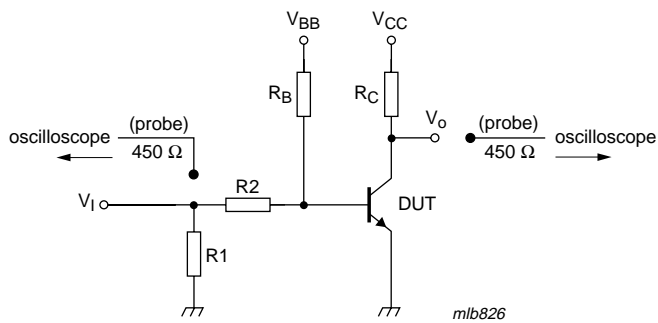
$T_{amb} = 25\text{ °C}$   
 (1)  $I_C/I_B = 100$   
 (2)  $I_C/I_B = 50$   
 (3)  $I_C/I_B = 10$

**Fig 20. TR2 (PNP): Collector-emitter saturation resistance as a function of collector current; typical values**

**8. Test information**

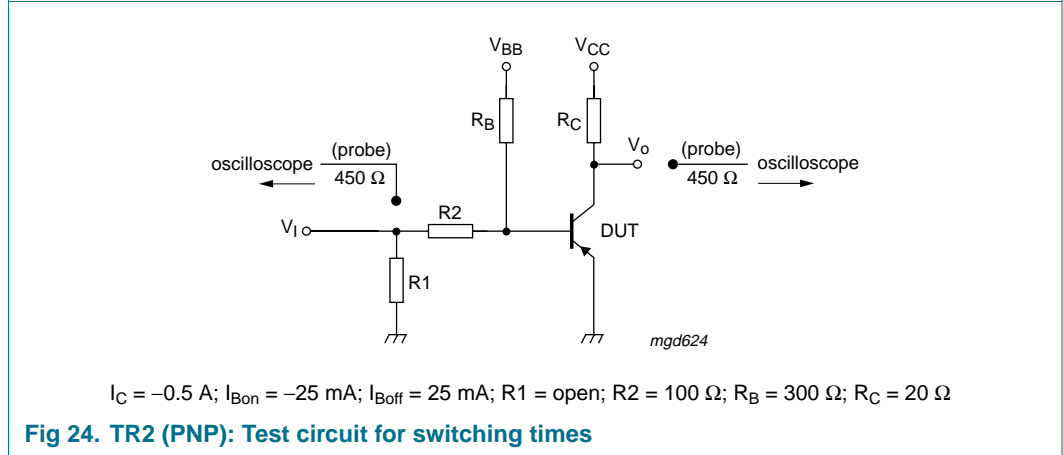
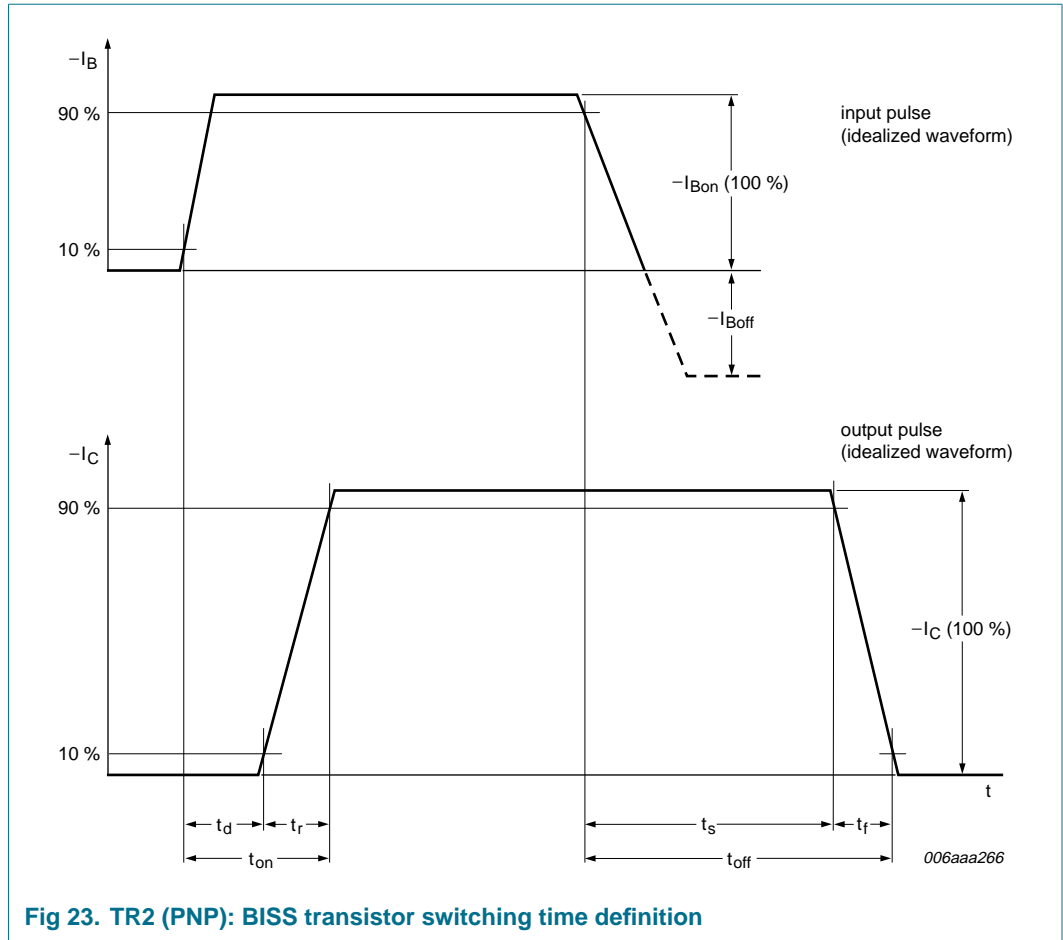


**Fig 21. TR1 (NPN): BISS transistor switching time definition**

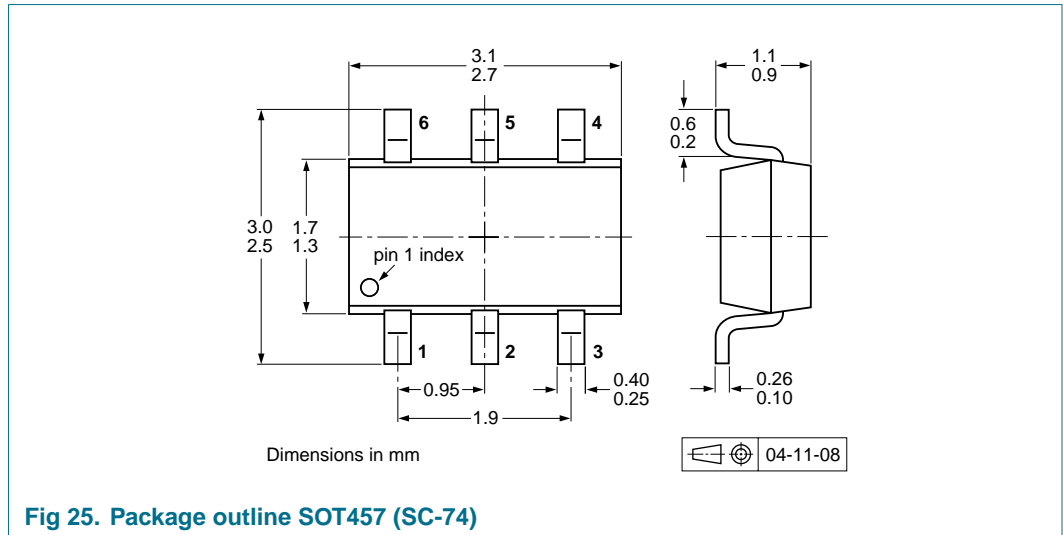


$I_C = 0.5 \text{ A}$ ;  $I_{B_{on}} = 25 \text{ mA}$ ;  $I_{B_{off}} = -25 \text{ mA}$ ;  $R_1 = \text{open}$ ;  $R_2 = 100 \text{ } \Omega$ ;  $R_B = 300 \text{ } \Omega$ ;  $R_C = 20 \text{ } \Omega$

**Fig 22. TR1 (NPN): Test circuit for switching times**



## 9. Package outline



## 10. Packing information

**Table 8: Packing methods**

The indicated -xxx are the last three digits of the 12NC ordering code. [\[1\]](#)

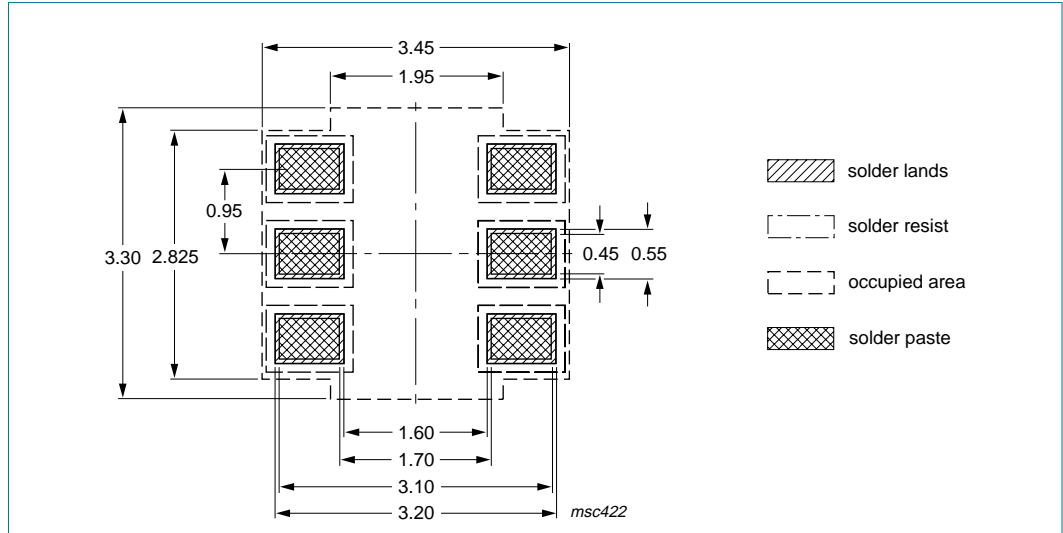
Type number	Package	Description	Packing quantity	
			3000	10000
PBSS4160DPN	SOT457	4 mm pitch, 8 mm tape and reel; T1 <a href="#">[2]</a>	-115	-135
		4 mm pitch, 8 mm tape and reel; T2 <a href="#">[3]</a>	-125	-165

[1] For further information and the availability of packing methods, see [Section 17](#).

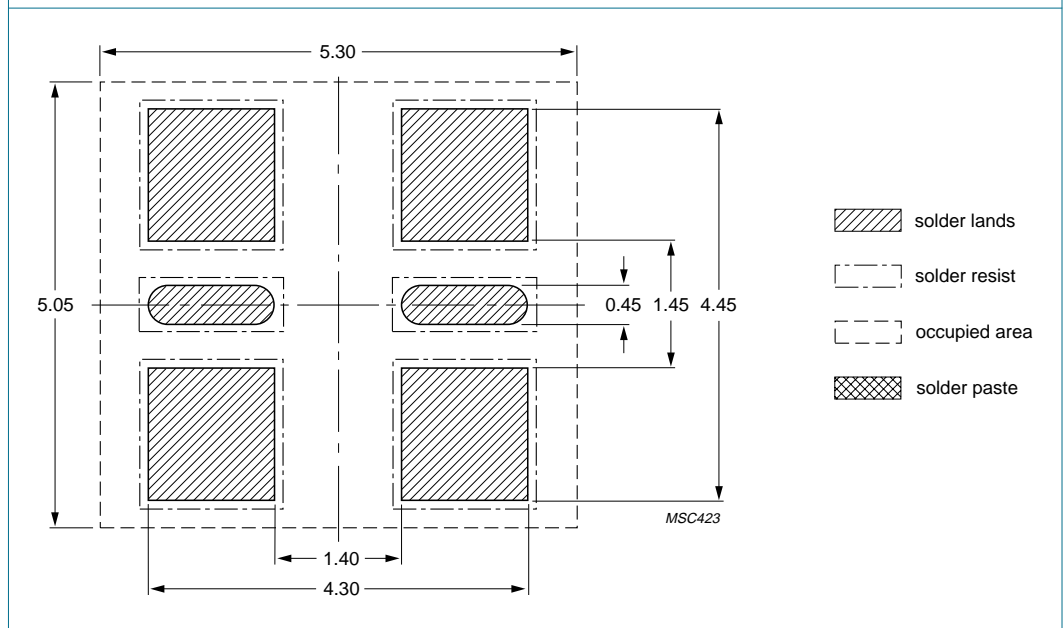
[2] T1: normal taping

[3] T2: reverse taping

**11. Soldering**



**Fig 26. Reflow soldering footprint**



**Fig 27. Wave soldering footprint**

## 12. Revision history

**Table 9: Revision history**

Document ID	Release date	Data sheet status	Change notice	Doc. number	Supersedes
PBSS4160DPN_2	20050714	Product data sheet	-	-	PBSS4160DPN_1
Modifications:					
<ul style="list-style-type: none"> <li>• Product status changed</li> <li>• <a href="#">Table 7 “Characteristics”</a>: Switching times parameters <math>t_d</math>, <math>t_r</math>, <math>t_{on}</math>, <math>t_s</math>, <math>t_f</math> and <math>t_{off}</math> added</li> <li>• <a href="#">Figure 21 “TR1 (NPN): BISS transistor switching time definition”</a>: added</li> <li>• <a href="#">Figure 22 “TR1 (NPN): Test circuit for switching times”</a>: added</li> <li>• <a href="#">Figure 23 “TR2 (PNP): BISS transistor switching time definition”</a>: added</li> <li>• <a href="#">Figure 24 “TR2 (PNP): Test circuit for switching times”</a>: added</li> <li>• <a href="#">Section 10 “Packing information”</a>: added</li> <li>• <a href="#">Section 11 “Soldering”</a>: added</li> <li>• <a href="#">Section 16 “Trademarks”</a>: added</li> </ul>					
PBSS4160DPN_1	20040603	Objective data sheet	-	9397 750 12701	-



## 13. Data sheet status

Level	Data sheet status <sup>[1]</sup>	Product status <sup>[2] [3]</sup>	Definition
I	Objective data	Development	This data sheet contains data from the objective specification for product development. Philips Semiconductors reserves the right to change the specification in any manner without notice.
II	Preliminary data	Qualification	This data sheet contains data from the preliminary specification. Supplementary data will be published at a later date. Philips Semiconductors reserves the right to change the specification without notice, in order to improve the design and supply the best possible product.
III	Product data	Production	This data sheet contains data from the product specification. Philips Semiconductors reserves the right to make changes at any time in order to improve the design, manufacturing and supply. Relevant changes will be communicated via a Customer Product/Process Change Notification (CPCN).

[1] Please consult the most recently issued data sheet before initiating or completing a design.

[2] The product status of the device(s) described in this data sheet may have changed since this data sheet was published. The latest information is available on the Internet at URL <http://www.semiconductors.philips.com>.

[3] For data sheets describing multiple type numbers, the highest-level product status determines the data sheet status.

## 14. Definitions

**Short-form specification** — The data in a short-form specification is extracted from a full data sheet with the same type number and title. For detailed information see the relevant data sheet or data handbook.

**Limiting values definition** — Limiting values given are in accordance with the Absolute Maximum Rating System (IEC 60134). Stress above one or more of the limiting values may cause permanent damage to the device. These are stress ratings only and operation of the device at these or at any other conditions above those given in the Characteristics sections of the specification is not implied. Exposure to limiting values for extended periods may affect device reliability.

**Application information** — Applications that are described herein for any of these products are for illustrative purposes only. Philips Semiconductors make no representation or warranty that such applications will be suitable for the specified use without further testing or modification.

## 15. Disclaimers

**Life support** — These products are not designed for use in life support appliances, devices, or systems where malfunction of these products can reasonably be expected to result in personal injury. Philips Semiconductors

## 17. Contact information

For additional information, please visit: <http://www.semiconductors.philips.com>

For sales office addresses, send an email to: [sales.addresses@www.semiconductors.philips.com](mailto:sales.addresses@www.semiconductors.philips.com)

customers using or selling these products for use in such applications do so at their own risk and agree to fully indemnify Philips Semiconductors for any damages resulting from such application.

**Right to make changes** — Philips Semiconductors reserves the right to make changes in the products - including circuits, standard cells, and/or software - described or contained herein in order to improve design and/or performance. When the product is in full production (status 'Production'), relevant changes will be communicated via a Customer Product/Process Change Notification (CPCN). Philips Semiconductors assumes no responsibility or liability for the use of any of these products, conveys no license or title under any patent, copyright, or mask work right to these products, and makes no representations or warranties that these products are free from patent, copyright, or mask work right infringement, unless otherwise specified.

## 16. Trademarks

**Notice** — All referenced brands, product names, service names and trademarks are the property of their respective owners.

## 18. Contents

<b>1</b>	<b>Product profile</b> . . . . .	<b>1</b>
1.1	General description . . . . .	1
1.2	Features . . . . .	1
1.3	Applications . . . . .	1
1.4	Quick reference data . . . . .	1
<b>2</b>	<b>Pinning information</b> . . . . .	<b>2</b>
<b>3</b>	<b>Ordering information</b> . . . . .	<b>2</b>
<b>4</b>	<b>Marking</b> . . . . .	<b>2</b>
<b>5</b>	<b>Limiting values</b> . . . . .	<b>2</b>
<b>6</b>	<b>Thermal characteristics</b> . . . . .	<b>4</b>
<b>7</b>	<b>Characteristics</b> . . . . .	<b>6</b>
<b>8</b>	<b>Test information</b> . . . . .	<b>12</b>
<b>9</b>	<b>Package outline</b> . . . . .	<b>14</b>
<b>10</b>	<b>Packing information</b> . . . . .	<b>14</b>
<b>11</b>	<b>Soldering</b> . . . . .	<b>15</b>
<b>12</b>	<b>Revision history</b> . . . . .	<b>16</b>
<b>13</b>	<b>Data sheet status</b> . . . . .	<b>17</b>
<b>14</b>	<b>Definitions</b> . . . . .	<b>17</b>
<b>15</b>	<b>Disclaimers</b> . . . . .	<b>17</b>
<b>16</b>	<b>Trademarks</b> . . . . .	<b>17</b>
<b>17</b>	<b>Contact information</b> . . . . .	<b>17</b>



© Koninklijke Philips Electronics N.V. 2005

All rights are reserved. Reproduction in whole or in part is prohibited without the prior written consent of the copyright owner. The information presented in this document does not form part of any quotation or contract, is believed to be accurate and reliable and may be changed without notice. No liability will be accepted by the publisher for any consequence of its use. Publication thereof does not convey nor imply any license under patent- or other industrial or intellectual property rights.

Date of release: 14 July 2005  
Document number: PBSS4160DPN\_2

Published in The Netherlands